

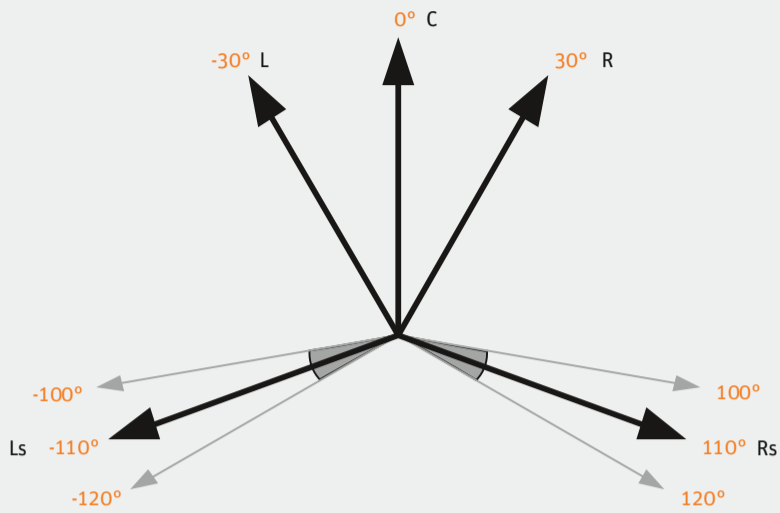

Place the loudspeakers at the correct angle
(ITU-R BS.775-1)



For 2-channel stereo use $\pm 30^\circ$

For 7.1 high definition systems
(no international standards)

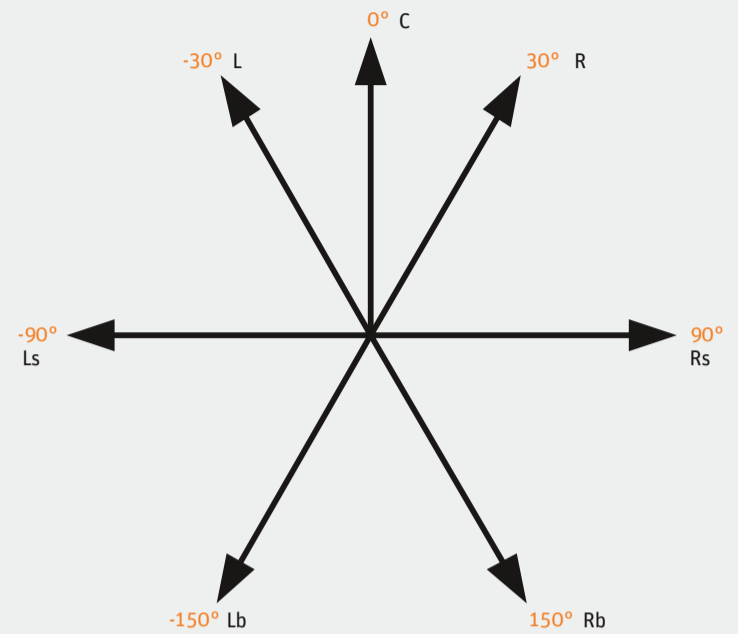

Place the loudspeakers at the same distance

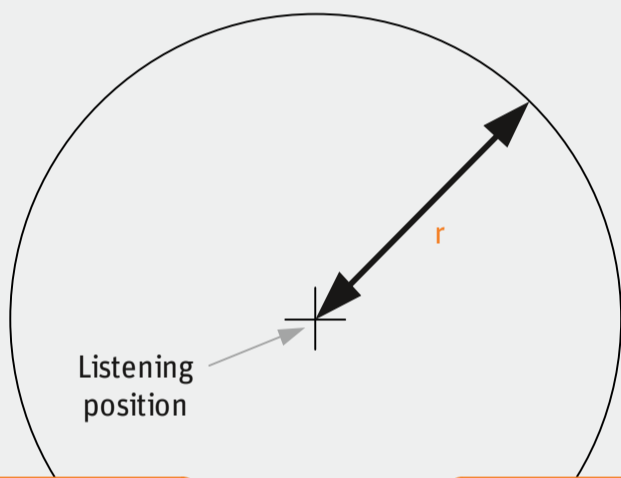

Small near-field systems:
 $r_{max} = 4 \text{ m (12')}$
 $r_{typical} = 1 - 2 \text{ m (3 - 6')}$
 $r_{min} = 0.75 \text{ m (2.5')}$

Large mid-field systems:
 $r_{max} = 8 \text{ m (24')}$
 $r_{typical} = 2 - 4 \text{ m (6 - 12')}$
 $r_{min} = 1.5 \text{ m (5')}$

Delay closer loudspeakers by $30 \mu\text{s/cm}$
($76 \mu\text{s/inch}$)

Use the furthest loudspeaker as a reference

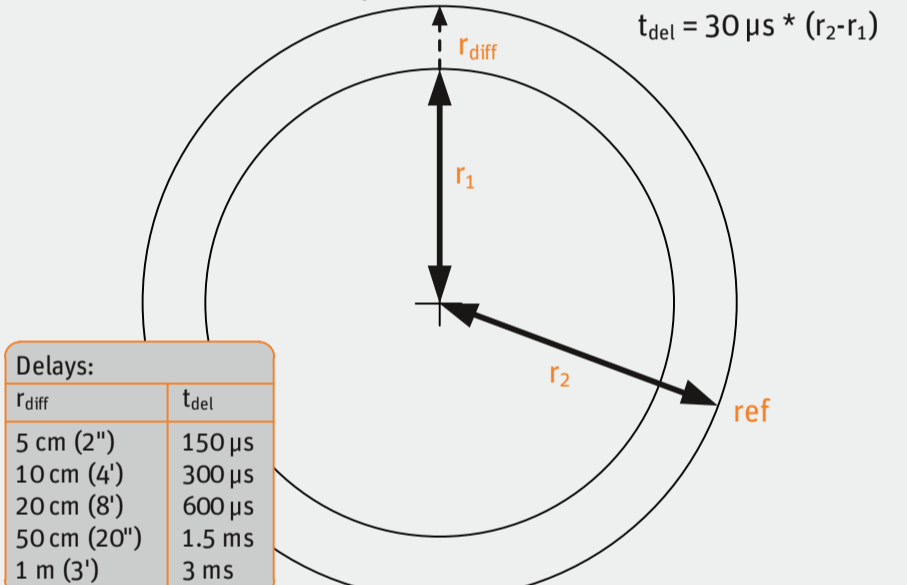

Horizontal: Point loudspeakers at listening position

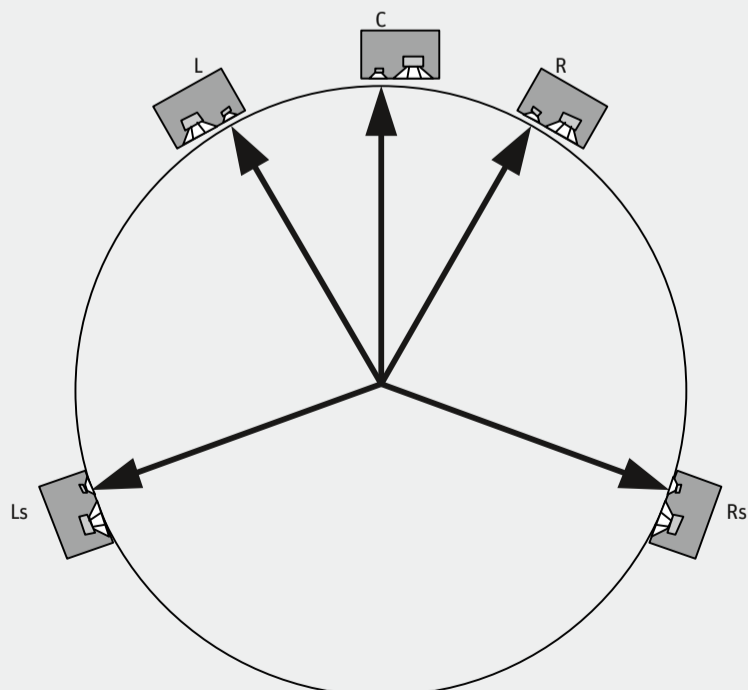

Use the acoustical axis as a reference

Symmetrical loudspeaker and object placement in the room improves stereo imaging, d_1, d_2, d_3

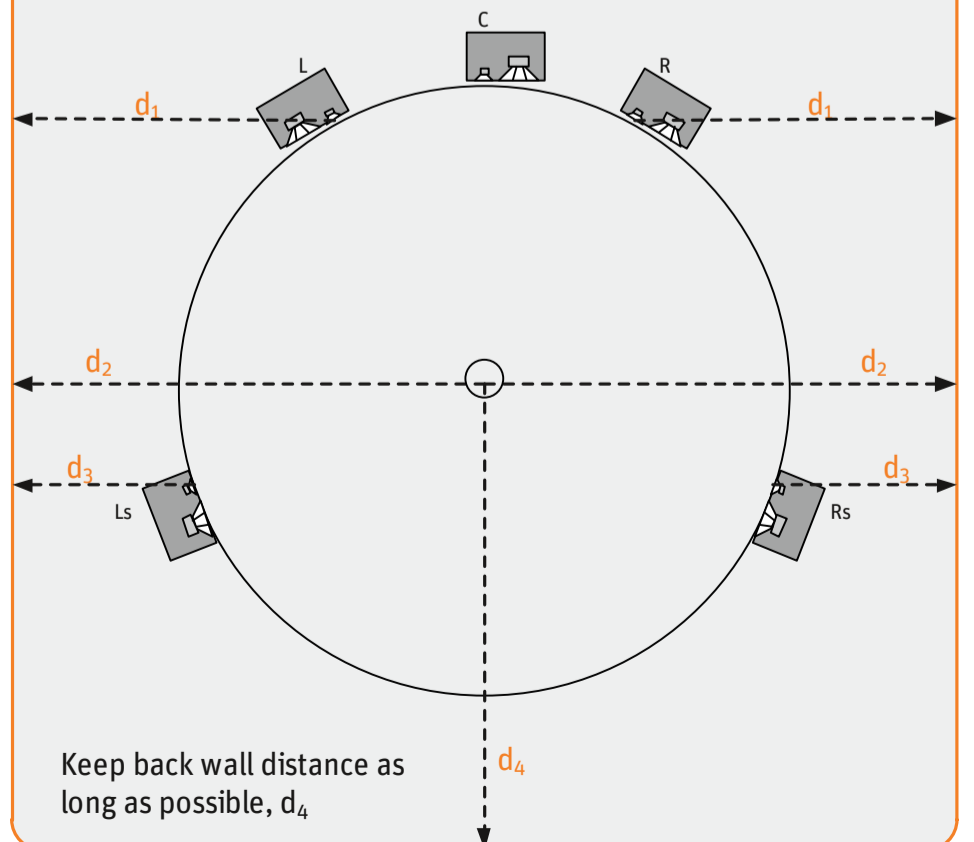

Keep back wall distance as long as possible, d_4



Acoustical axis and cabinet orientation

Use acoustical axis as a reference point

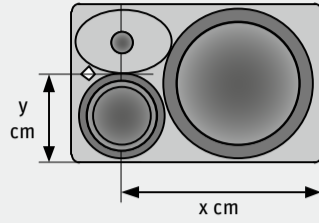

Recommended cabinet orientation for a wide usable listening area

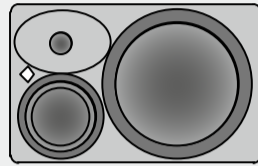

Not recommended cabinet orientation, except for fixed listening positions

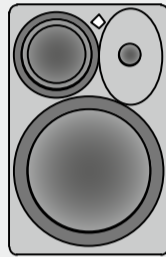

Acoustical controls

Against a wall

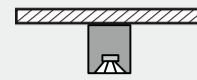

Solid: Bass = -5 dB
Soft: Bass = -2.5 dB

In a corner

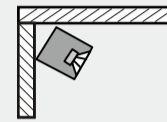

Bass = -7.5 dB
Low-Mid = -1.5 dB

Near a desktop

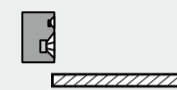

Small: Low-Mid = -1.5 dB
Large: Low-Mid = -3 dB

Free standing

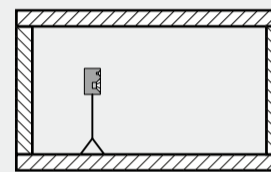

Live: Treble = -1 dB
Bass = -2.5 dB
Dead: All 0 dB

Distance from the wall

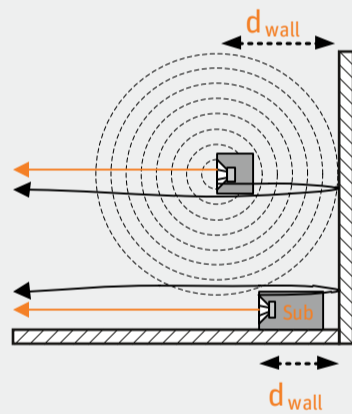
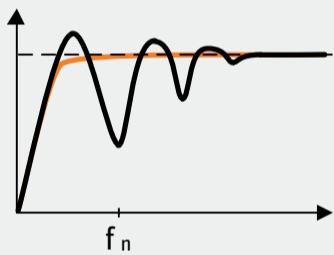

Full Range Loudspeakers

Avoid $d_{wall} = 0.8 - 2.0$ m

Bass Managed Loudspeakers

Avoid $d_{wall} = 0.8 - 1.0$ m

Subwoofers

Avoid $d_{wall} = > 0.8$ m

Vertical plane: Point the loudspeakers at the listening position. Avoid objects between the loudspeaker and listening position.

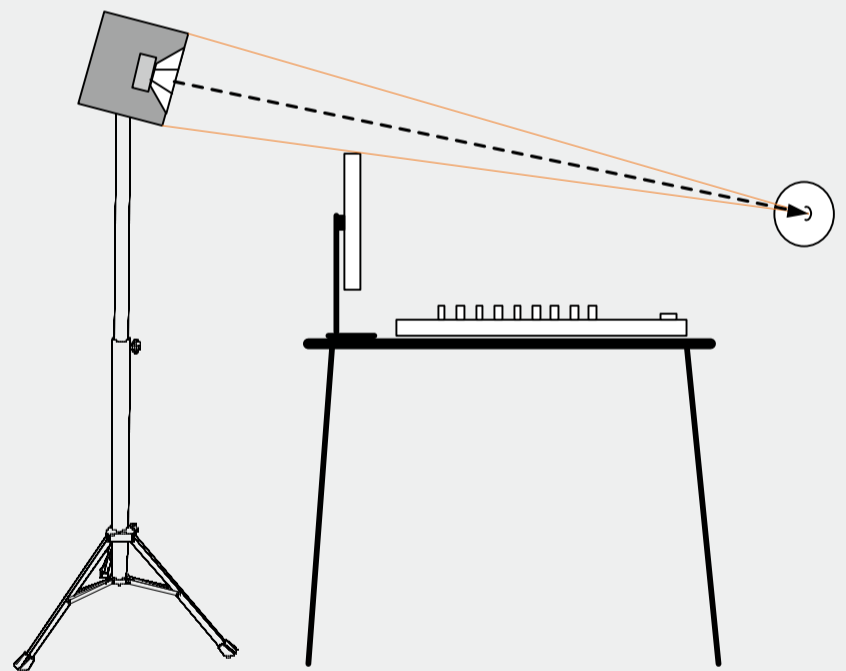

Arranging the desktop: uncluttered and symmetrical

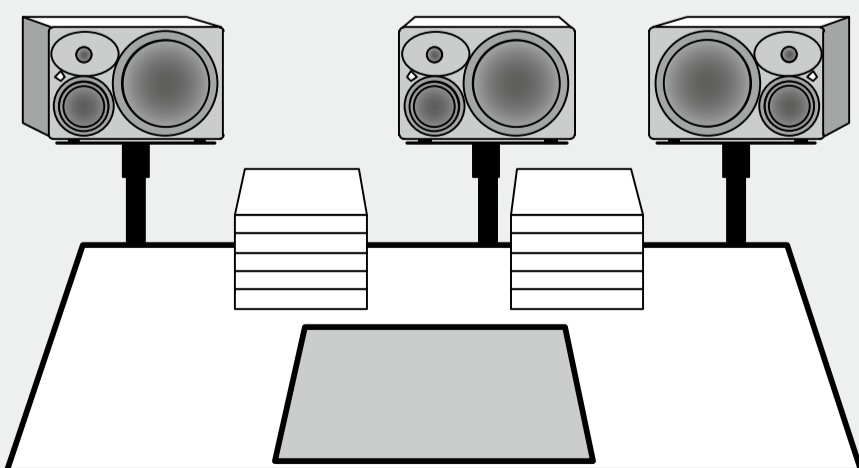

Avoid reflections for a smooth midrange

